

FORMWORKS FOR COLUMNS

Topfinish consists of two elements of polystyrene and are joined by traditional carpentry. The blown-out polystyrene is able to bear the crush weight of a normal pilaster. The inner revetment is impact resistant and allows a second use and a face look.

Rapidoget includes a system of closure with a belt in steel. This new way of closure is quick and safe and allows to compress the formwork and obtain a higher resistance to the pressure of cement. Rapidoget products consist of two structural elements and can be used again to construct various forms.

Monotub is a disposable formwork in water-proof materials with higher mechanic resistance characteristics. It is light and easy to handle and reduces the time of installation and removal in comparison to a common cardboard tube.

Quadriforma can be disposable or recycled in the version of Rapidoget. It is circular from the outside and the inside is made in different sizes upon request.

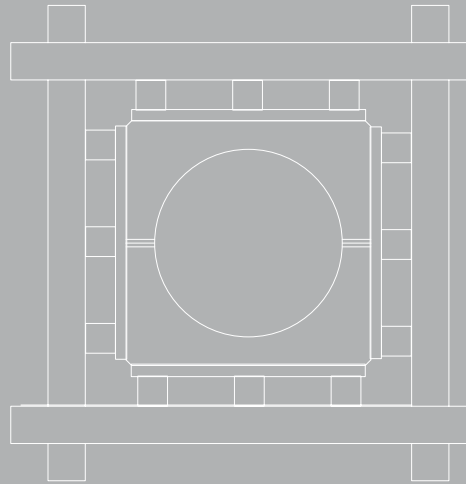

recycled columns with bases and capitals

TOPFINISH



Topfinish has a conical body, an assembled base and capital; revetment Syform and Perform.

RAPIDOGET

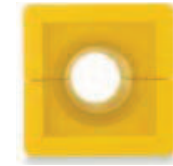

Rapidoget has a circular self-carrying foot and revetment Syform and Perform.

MONOTUB



Monotub formwork is plain and assembles with a base and capital with or without revetment Syform (the elements can be supplied separately or already installed).

DISPOSABLE with reinforced masking tape

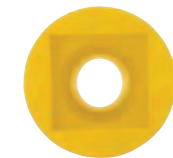

This is a convex formwork with a circular self-carrying foot, a tape of glass fibre and revetment Syform.



The products of using caissons for topfinish columns are columns of cement with circular section and plain surface, textures similar to wood, plain or relieved, and designs or pilasters.
 These are formworks with a square foot projected to sustain the pressure of cement without being crushed and can be recycled more than once. They have profiles for lining of the two halves.



SYSTEM OF CLOSING

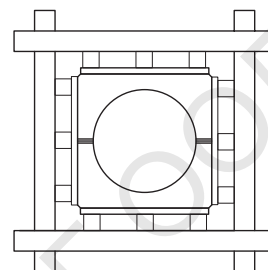

INSTALLATION

Topfinish formworks must be blocked inside the metal ware unit and driven to compression in the correct way to be able to resist against the jet pressure.

REMOVAL

The lightness of polystyrene and revetment materials make the operation quick and easy right after the day of jetting.

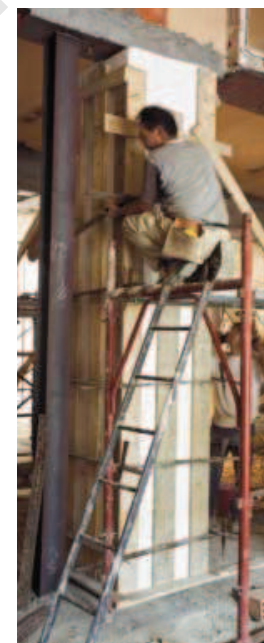

RESISTANCE TO COMPRESSION OF POLYSTYRENE FORMWORKS

JET HEIGHT MT	PRESSURE CLS KN/M ²	RESISTANCE TO COMPRESSION EPS WITH DEFORMATION LESS OR EQUAL TO 2% KN	JET RAISE SPEED - CLS FLUID M/H
2,5	62,5	60	< 3
3	75	60	< 3
3,5	87,5	80	< 3
4	100	80	< 3
4,5	112,5	80	< 2,5
5	125	100	< 2,5
5,5	137,5	100	< 2,5
6	150	100	< 2,5

REMOVER

Arbloc recommends the use of a remover deprived of solvents or antioxidants that can dissolve the blown-out polystyrene. It is also advised to use of the remover in the proportion of more than 50 m²/l. The excessive doses can cause damages that sometimes can be seen only after removal.



Rapidoget is a formwork that has a system of closure with steel sheets. This system is quick and safe and allows to compress the formwork to obtain higher resistance against the pressure of cement. It consists of two structural elements with a core in polystyrene, the outer part is lined with resin and fibre while the inside is of different sizes and forms.



SYSTEM OF CLOSING

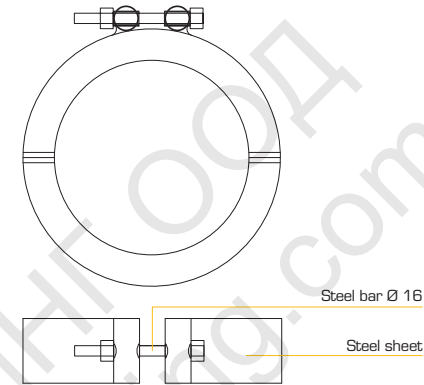

INSTALLATION

Rapidoget products are easily installed because they are light. Once the two semi sheets are united, the steel sheets are fixed placing them according to the given scheme.

REMOVAL

To remove Rapidoget the sheets should be let loose and untwisted from one another. It is possible to remove it already the day after the jet, even in the winter, because the blown-out polystyrene in the formwork isolates the jet from the cold thus accelerating the maturing.



PRESSURE OF CEMENT IN JET RAISE FUNCTION

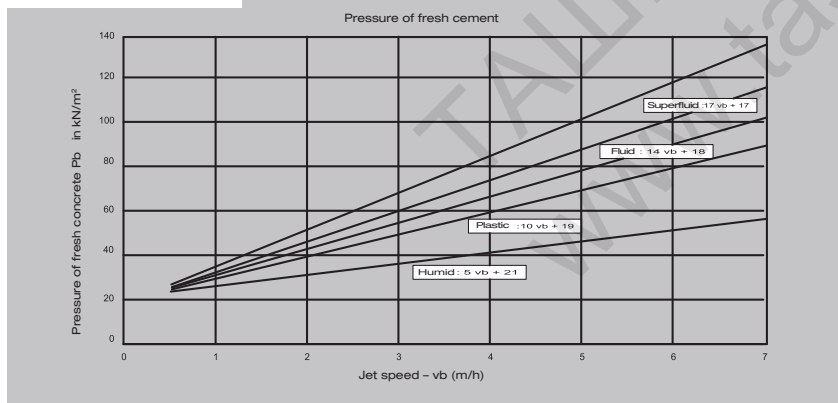



A square pilaster is a disposable formwork to make pilasters with square or rectangular sections and a face look of quality.

It consists of a form in blown-out polystyrene lined with an iron sheet in the inside and isolated with a masking tape from the outside to preserve the pressure of the cement. It is light and easy and quick to handle without using a lifting crane and helps reduce the costs of labour in comparison to traditional systems.

The removal is done the day after the jet by cutting the outside tape.



ABS PLAIN

The surface is lined with iron sheets in polypropylene 1 mm thick and reinforced with glass fibre. Polypropylene is a kind of material which allows a very plain face look and removal without using a remover.



APV DRESSED WOOD

Sheets of dressed wood 7 mm thick are glued to the polystyrene in order not to lose the cement mortar between two pieces. They come in two sizes: 36 mm for diameter up to 300 mm and 45 mm for other diameters.



ASV WOOD TEXTURES IN RELIEF

Struktoplan panels, multiply plywood panels of 5.5 mm with revetment in phenol resin, are glued to the polystyrene and give the cement the looks of refined or aged wood. Size 45 mm.



AGP MOLD IN RUBBER

Molds in polyurethane rubber added to a polystyrene structure give the cement the looks of fake travertine.



basic designs and standard capitals

basic designs and standard capitals

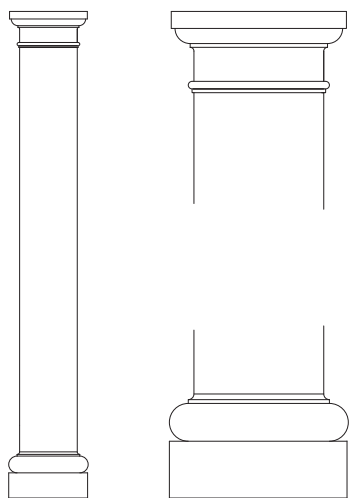

model 1

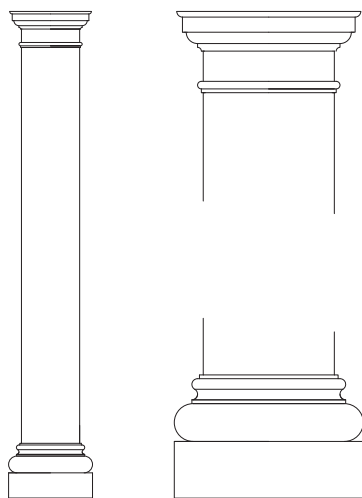

model 2

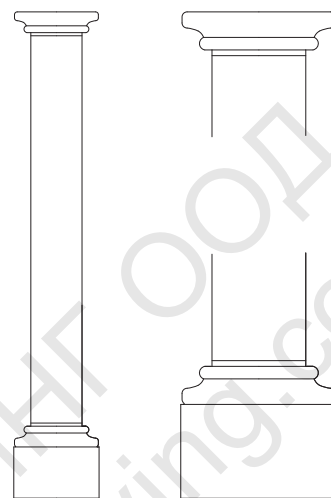

model 5

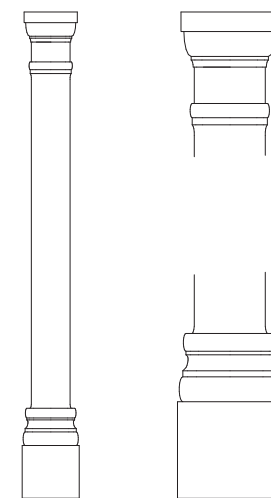

model 6

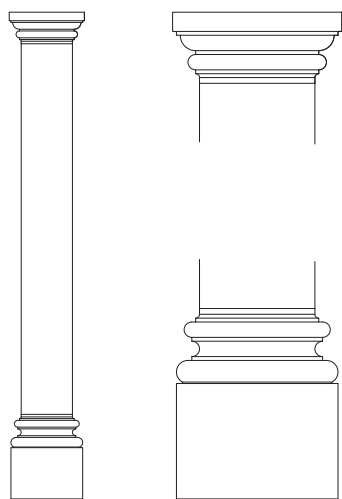

model 3

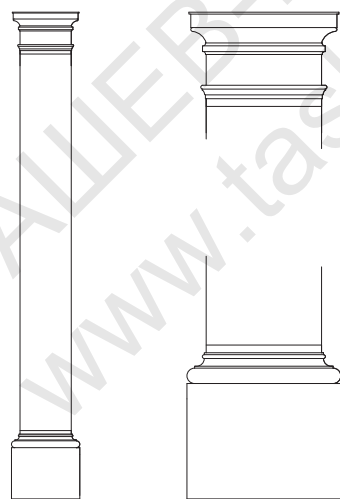

model 4

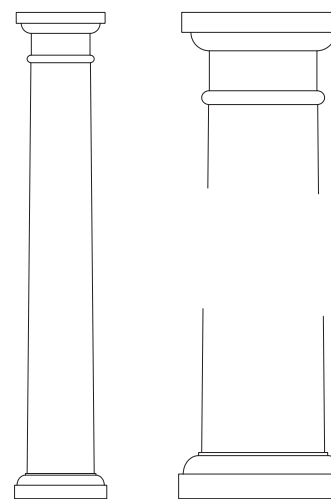

model 7

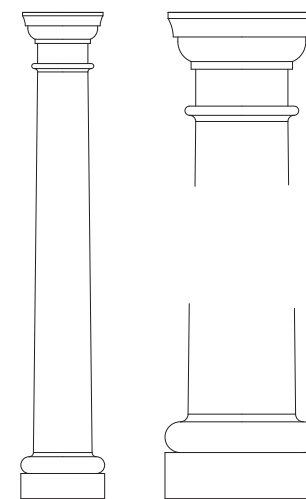

model 8

basic designs and standard capitals

basic designs and standard capitals

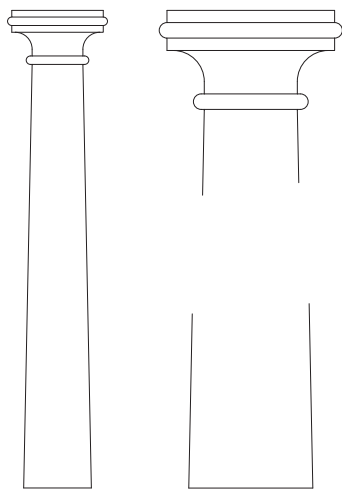

model 9

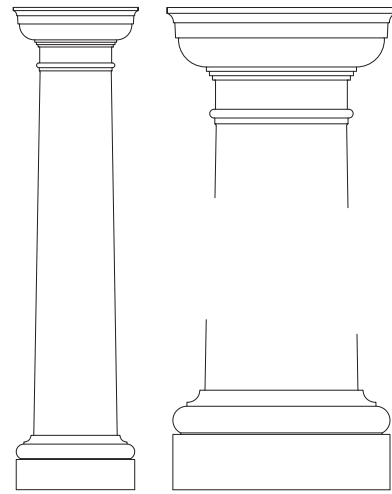

model 10

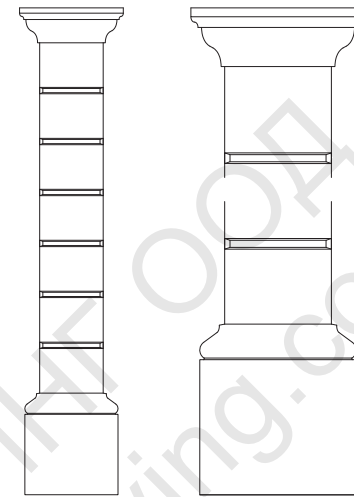

model 13 - Square foot

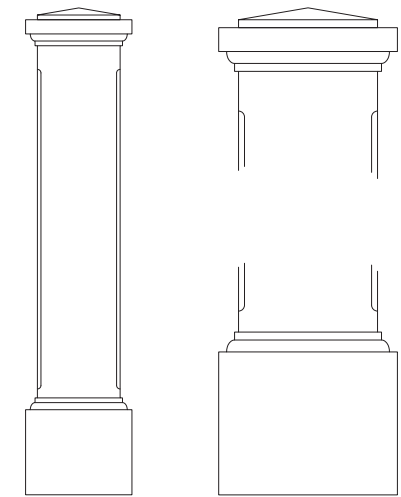

model 14 - Square foot

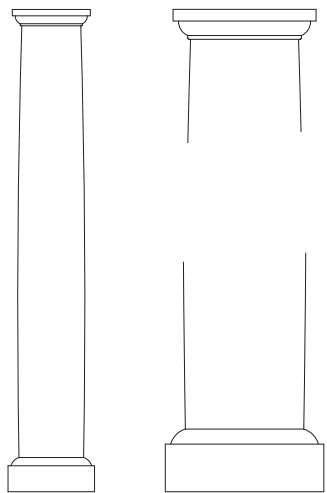

model 11

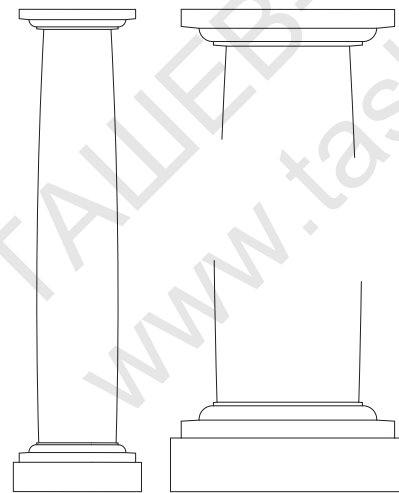

model 12

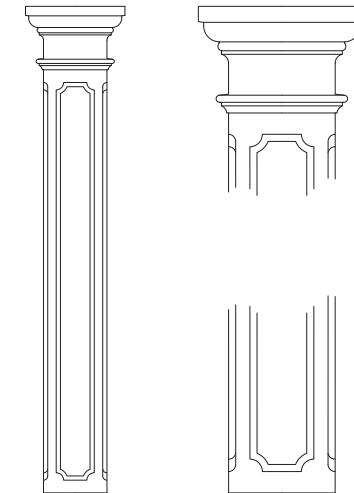

model 15 - Square foot

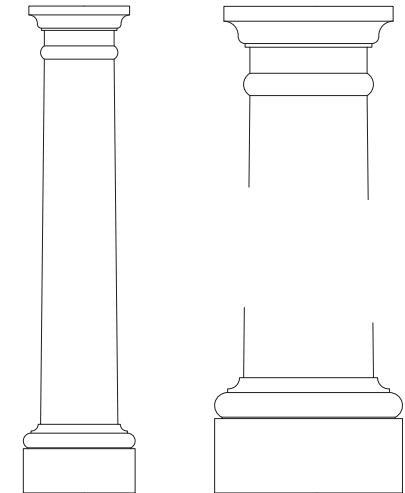

model 16 - Square foot

photo gallery



